

## Ficha Técnica

# ESTORES DE ROLO C/ CAIXA E GUIA

### • CARACTERÍSTICAS GERAIS:

O estore de rolo com caixa e guias é uma excelente opção para quartos, auditórios e espaços onde haja necessidade de escurecer na totalidade. O funcionamento pode ser sistema de corrente, motorizado ou kit de manivela.

### Componentes

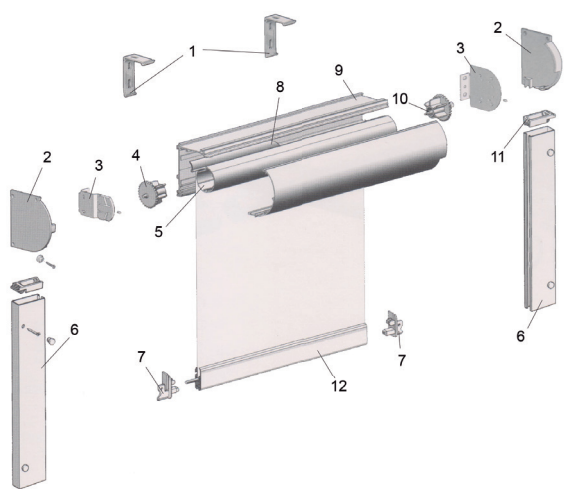

1. Suporte Chapa Parede/Tecto

7. Topo Terminal

2. Tampa Dto./Esq.

8. Perfil PVC para Tubo

3. Suporte para Manivela

9. Caixa 90mm

4. Topo com Perno

10. Topo com Perno Quadrado 7x7mm

5. Tubo Redondo 42mm

11. Embute para Tampa

6. Guia Lateral

12. Terminal 12x42mm

### • DETALHES



Pormenor do motor



Pormenor da corrente

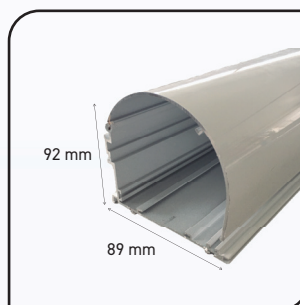

Medidas da caixa

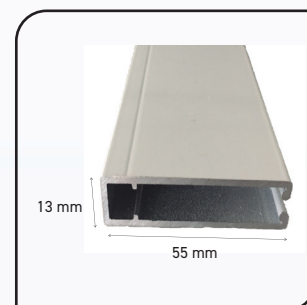

Medidas do perfil